



a·light

ALOFT



**ARTICULATE
YOUR IDEAS
WITH LIGHT**

With fully articulating elbows and connectors, designers can create unique configurations.

a·light

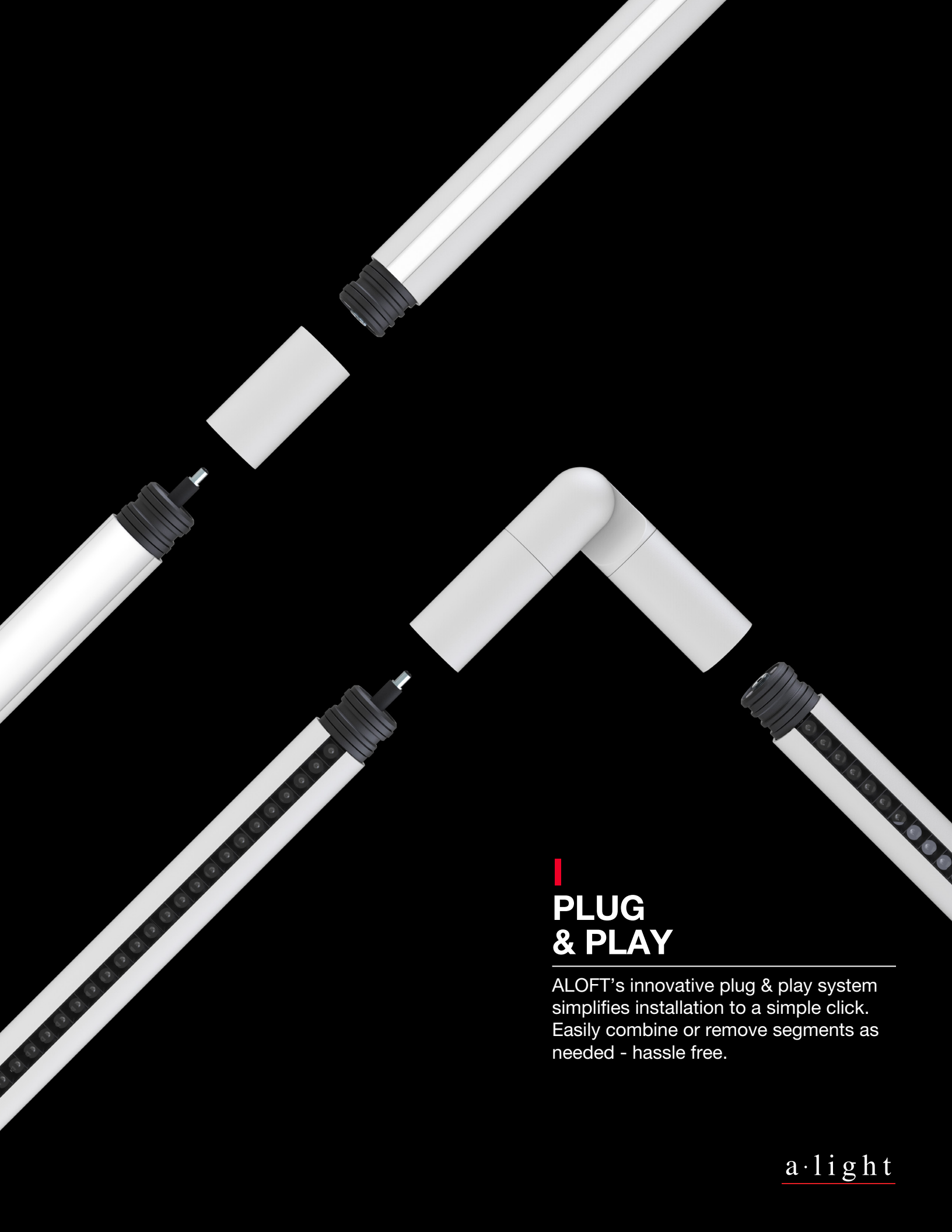

**PLUG
& PLAY**

ALOFT's innovative plug & play system simplifies installation to a simple click. Easily combine or remove segments as needed - hassle free.

a·light

A photograph of a modern, minimalist staircase made of dark grey concrete. The staircase has a zig-zagging path. A person is walking on the stairs, their figure is blurred, suggesting motion. The walls are also made of dark grey concrete panels with small circular holes. A bright, linear light fixture is mounted on the wall, following the zig-zag path of the stairs. The overall atmosphere is industrial and contemporary.

FOLLOWING LIGHT

Why compromise when you can adapt the lighting to its environment? ALOFT can be fine-tuned on-site to make last minute changes.



**BE
CREATIVE**

The swivel joiner has a wide horizontal rotation which allows for creative use of angles and maximum on-site adjustability.

a·light



ABSTRACTION MEETS GEOMETRY

Get more out of your light: use ALOFT to create unique patterns and make a lighting statement. No job is too complex for ALOFT.

a·light



360°

360°

200°

TOTAL LIBERTY

With a horizontal rotation of 200° and a 360° rotation joiner, ALOFT can be shaped into countless configurations.

a·light

LINEAR SEGMENTS

Each linear segment of ALOFT can be specified with a different light option creating unique looks that can be adjusted to any environment.

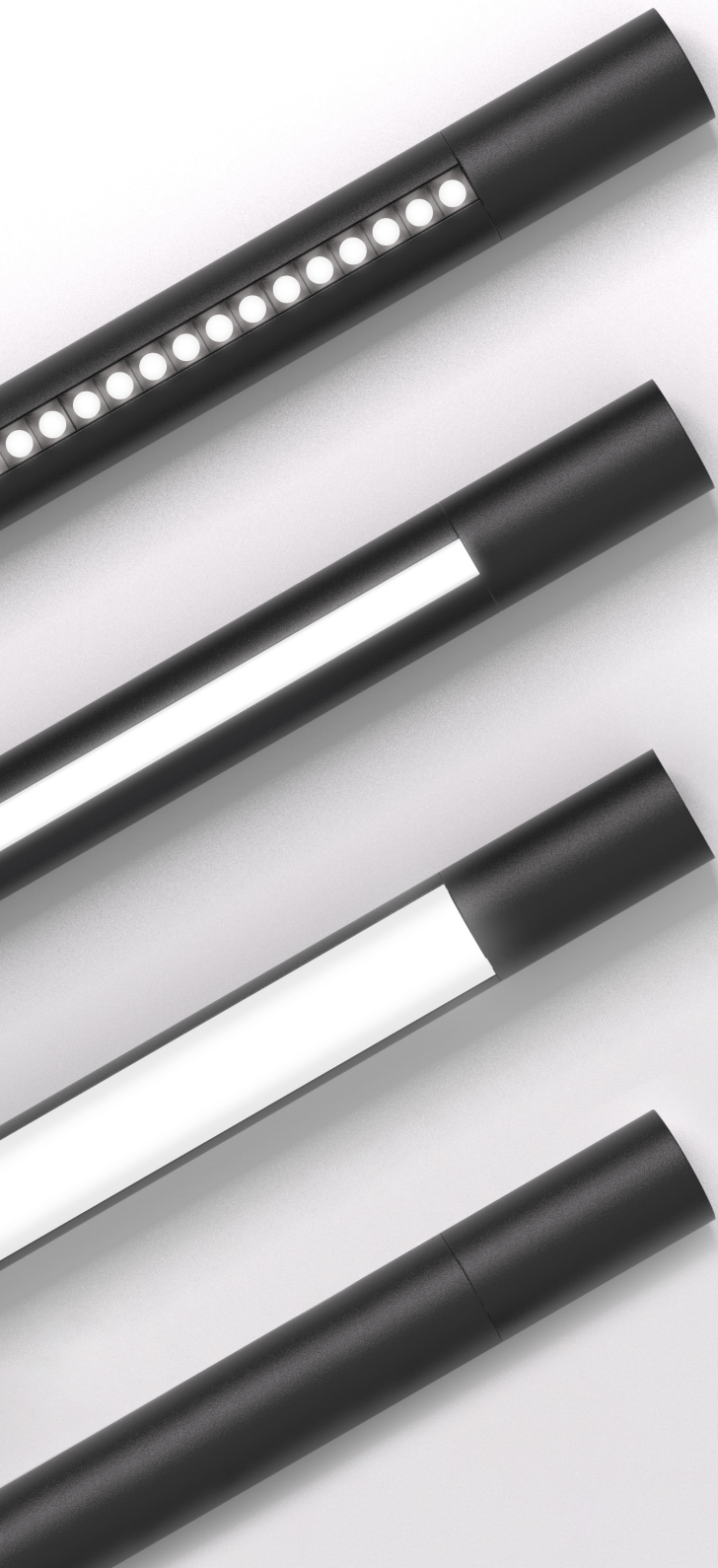

BAFFLED OPTIC

Offered with 22° or 55° beam angles (FWHM), the baffled optic offers a precise cut-off angle and recessed cell-lens technology to maintain a discreet and minimal presence.

HE TECH™

The proprietary HE Tech™ provides high performance and excellent light distribution from a narrow 1/2" aperture diffuse lens.

DIFFUSE LENS

Delivering beautifully refined light with uncompromised performance, the diffuse lens is used for a wider lambertian distribution.

NO LIGHT

Unlit segments to bridge the gap between lit sections.



HAVE IT YOUR WAY

ALOFT is a sleek, low profile, cylindrical luminaire system that enables specifiers the utmost control. Use the full swivel joiner to create a unique lighting environment.

a·light

01

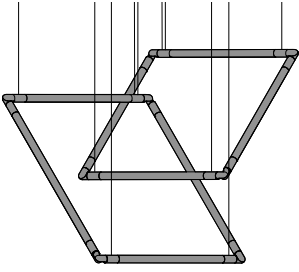

02

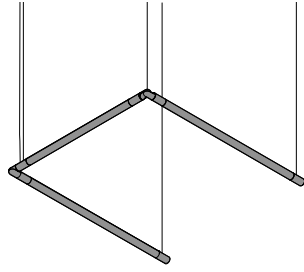

03

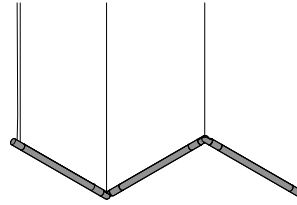

04

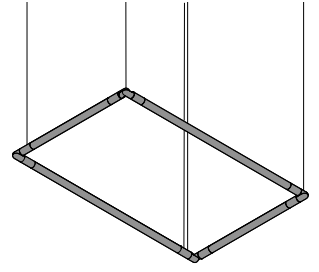

05

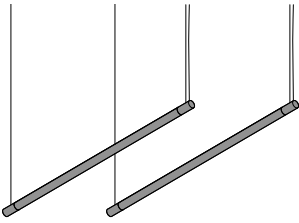

06

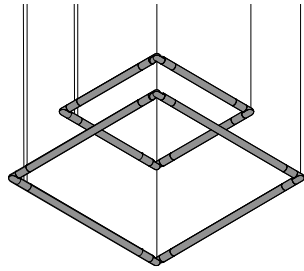

07

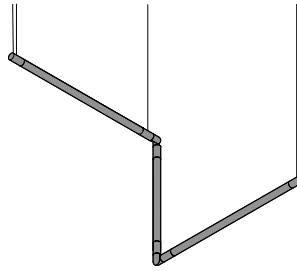

08

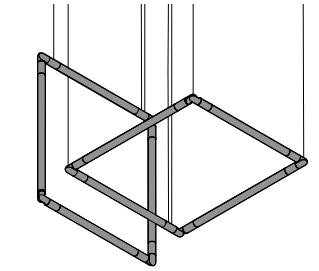

09

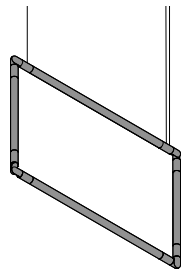

10

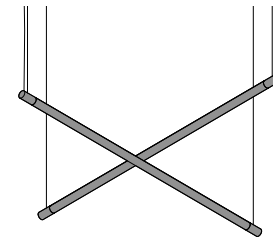

11

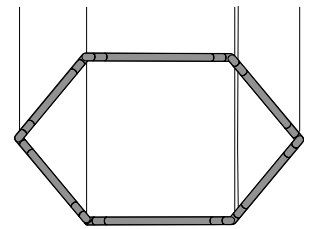

LIMITLESS OPTIONS

These are a few of our favorite ALOFT shapes and patterns. What will you create?

12

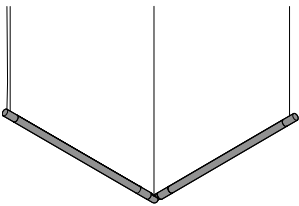

13

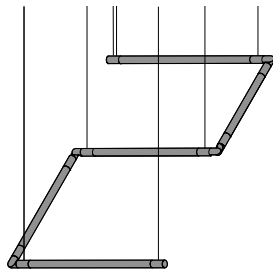

14

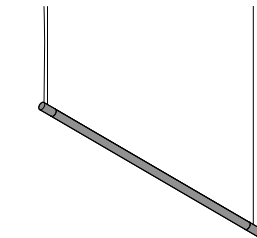

15

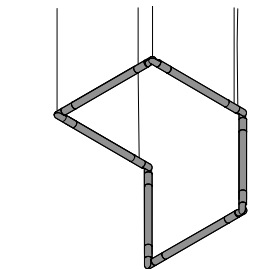

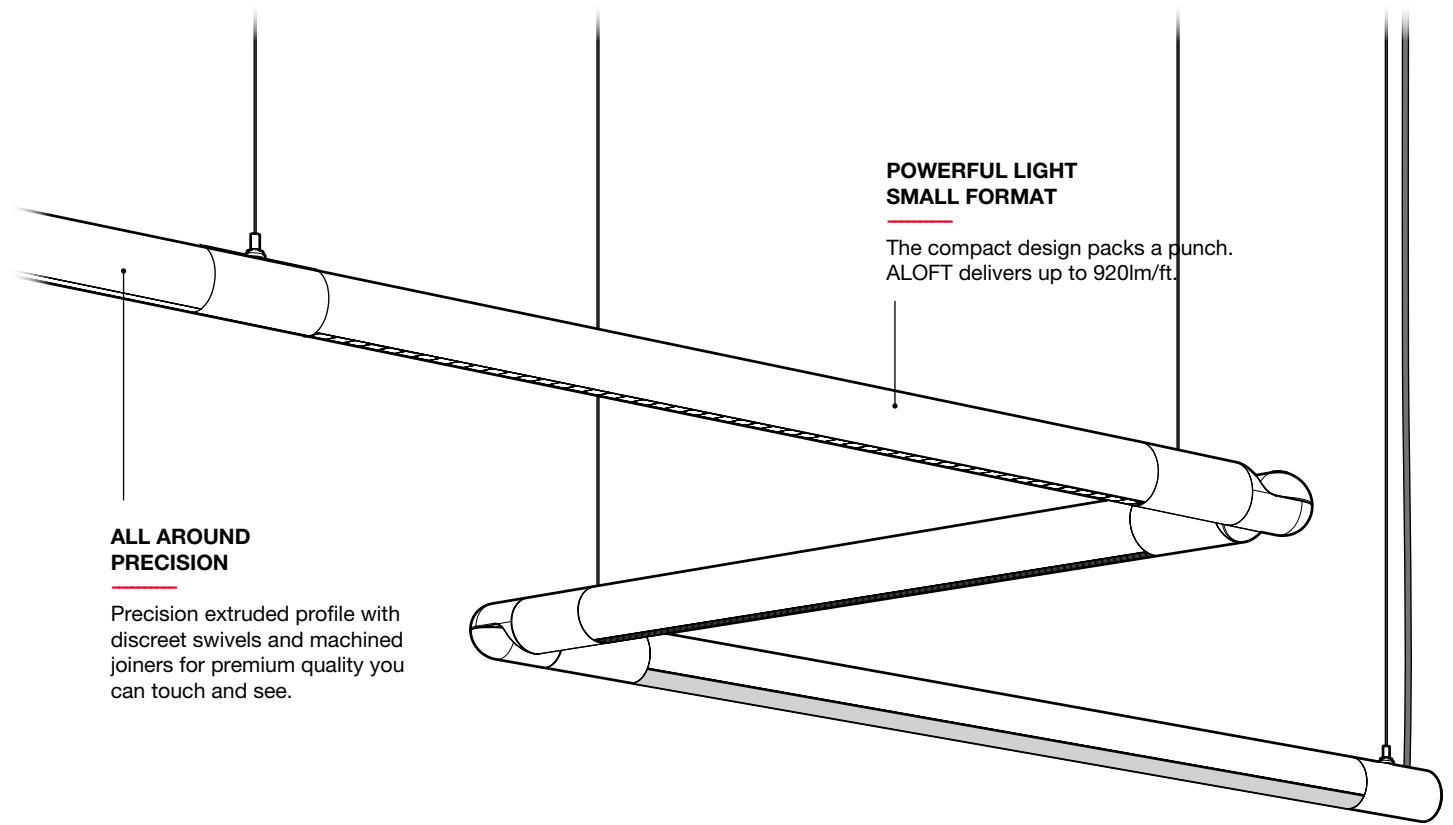

**POWERFUL LIGHT
SMALL FORMAT**

The compact design packs a punch. ALOFT delivers up to 920lm/ft.

**ALL AROUND
PRECISION**

Precision extruded profile with discreet swivels and machined joiners for premium quality you can touch and see.

**ADAPTS TO
ANY SPACE**

Easily re-configurable end-cap and joiner system makes ALOFT ideal for any given space from minimalist architectural hallways to next generation serpentine staircases.

**AIRCRAFT CABLE
MOUNTING**

A simple and elegant mounting system that provides a strong and inconspicuous effect of a floating form.

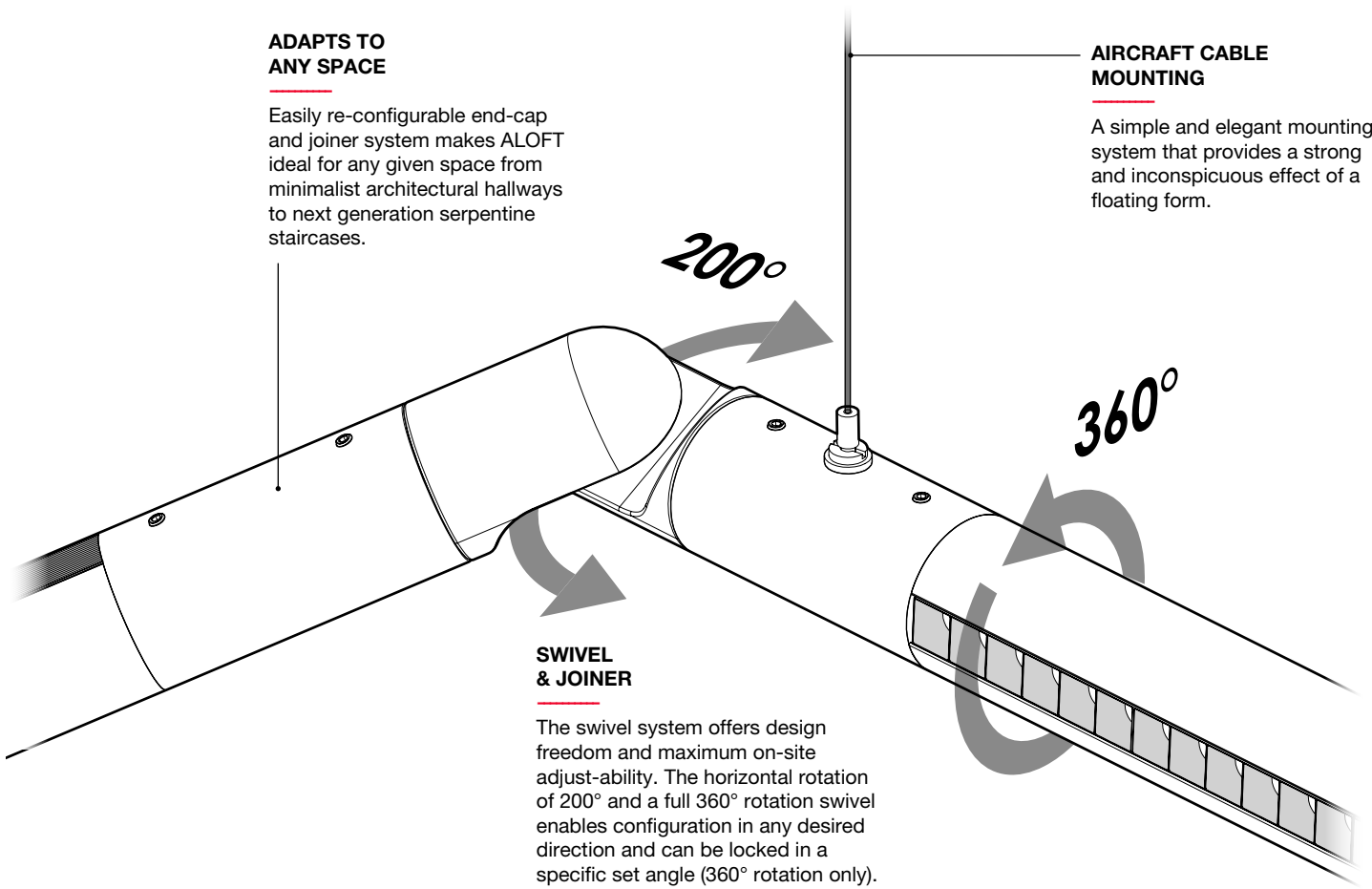

200°

360°

**SWIVEL
& JOINER**

The swivel system offers design freedom and maximum on-site adjust-ability. The horizontal rotation of 200° and a full 360° rotation swivel enables configuration in any desired direction and can be locked in a specific set angle (360° rotation only).



a·light